

ALUMNOS QUE ESTUVIERON EN PRIMERO DE PRIMARIA CON EL PROFESOR:

- JOSÉ LÓPEZ

ACTIVITY 1

1. Look and write. Use the words from the box.

are

aren't

is

isn't



1. They _____ running.



2. She _____ dancing.



3. They _____ jumping.



4. He _____ kicking a ball.

2. Read and colour.



Number fifteen has a red T-shirt.
 Number nineteen has blue socks.
 Number eleven has brown hair.
 Number seventeen has black hair.
 Number fourteen has a yellow T-shirt.
 Number twelve has a purple bag.



REVIEW MATERIAL ENGLISH AREA

ACTIVITY 2

1. Look at the pictures and complete the sentences.

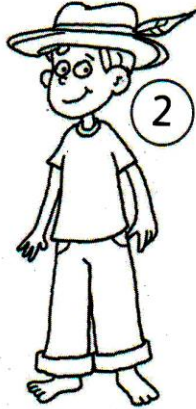
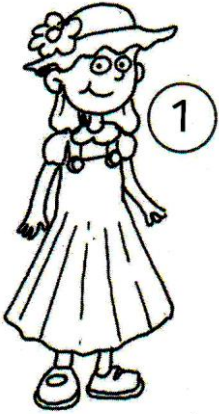

1. She's wearing a _____, a _____ and _____.

2. He's wearing a _____, a _____ and _____.

3. He's wearing a _____, _____ and _____.

2. Tick (✓) the correct sentence.

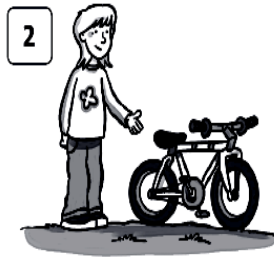

1 It's Mum's book.

It's Dad's book.

3 It's Grandma's umbrella.

It's Grandpa's umbrella.

2 This is my sister's bike.

This is my brother's bike.

4 This is my aunt's hat.

This is my uncle's hat.



REVIEW MATERIAL ENGLISH AREA

ACTIVITY 3

1. Match. Draw lines.

my father

my mother

my sister



me

my brother

my sister

the baby

2. Look and read. Then circle.

1.



Annie is

getting dressed / combing her hair.

2.



Dad is

brushing his teeth / making lunch.

3.



Sam is

reading / having a bath.

4.



Alex is

eating / playing.



REVIEW MATERIAL ENGLISH AREA

ACTIVITY 4 (EXTRA MATERIAL)

1. Read and draw.

1 Two **cats** are on the table.

2 A ball is under the chair.

3 A car is under the table.

4 A **bird** is in the box.

5 A train is on the chair.

6 Three **dogs** are in the box.

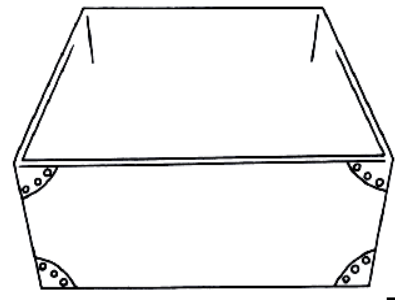
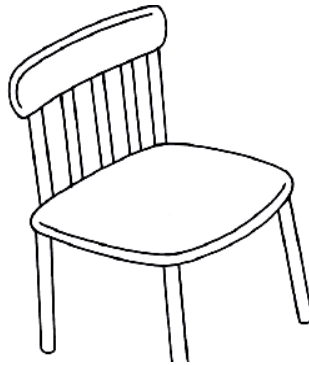
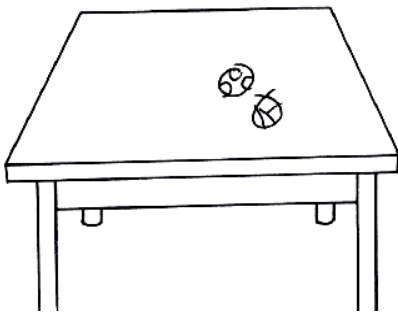

2. Read and write YES or NO.

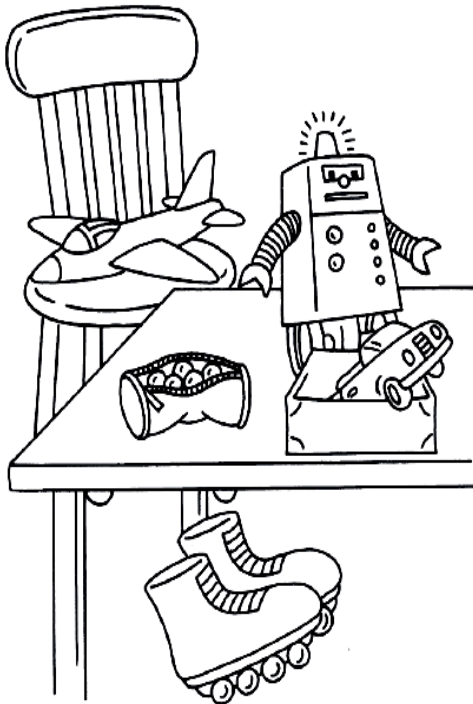

1 The plane is on the chair.

Yes

2 The skates are on the table.

3 The car is in the box.

4 The marbles are under the pencil case.

5 The robot is on the chair.

6 The skates are under the table.



REVIEW MATERIAL ENGLISH AREA

ACTIVITY 5 (EXTRA MATERIAL)

1. Look, read and write.

under ~~on~~ under in on in

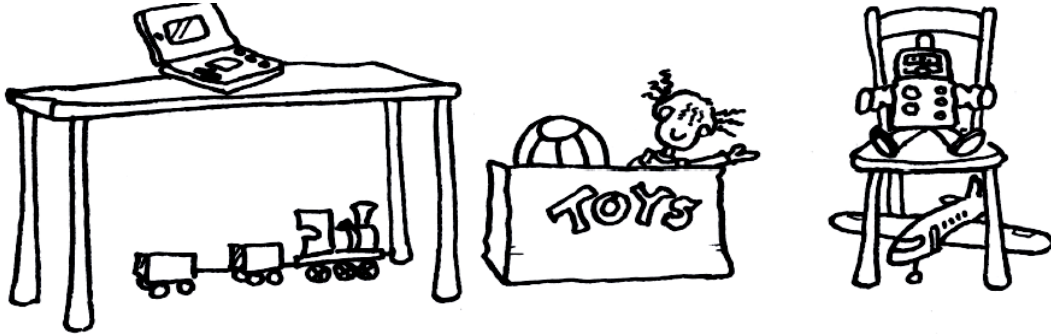

- 1 The robot is on the chair.
- 2 The train is under the table.
- 3 The doll is in the box.
- 4 The ball is in the box.
- 5 The computer game is on the table.
- 6 The plane is the under chair.

2. Read and match.

1 He's my father.



2 She's my grandmother.



3 He's my brother.



4 She's my sister.



5 He's my grandfather.

